

## Standard Preparation Sink for Dishwasher with 2 Bowls & Right Drain

ITEM # \_\_\_\_\_

MODEL # \_\_\_\_\_

NAME # \_\_\_\_\_

SIS # \_\_\_\_\_

AIA # \_\_\_\_\_

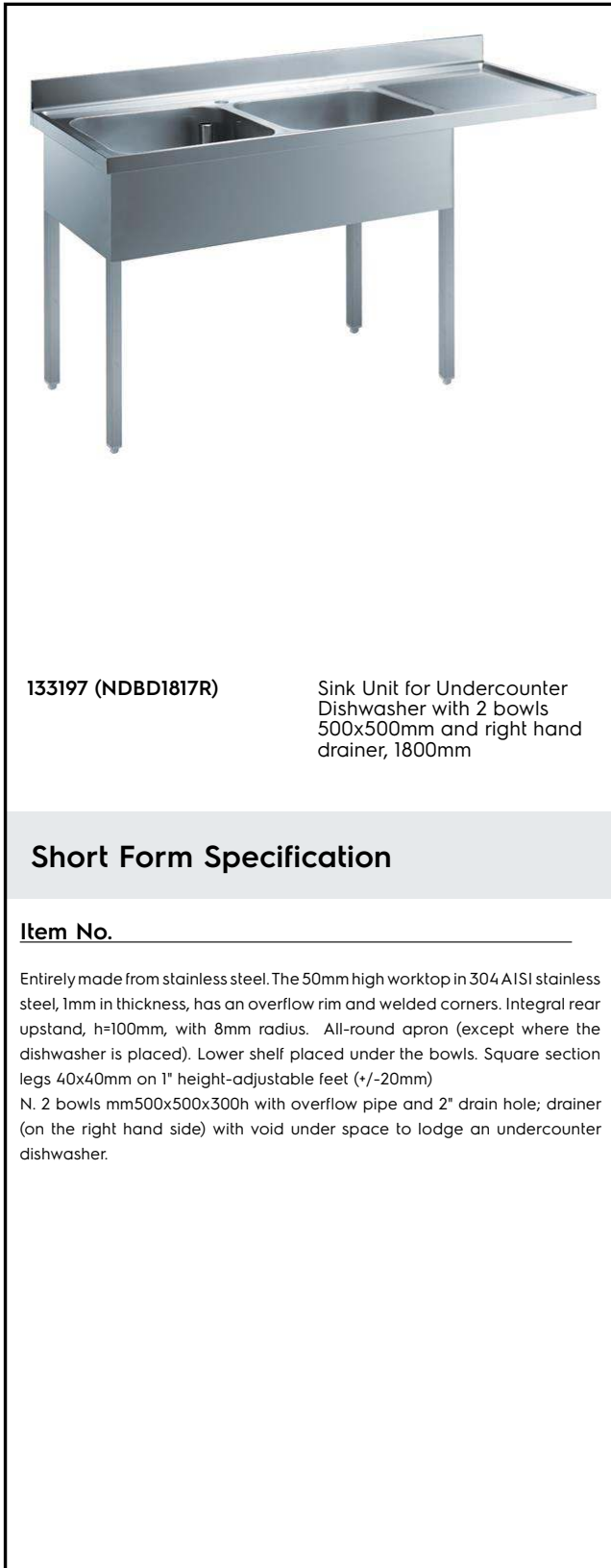
**133197 (NDBD1817R)**

 Sink Unit for Undercounter  
 Dishwasher with 2 bowls  
 500x500mm and right hand  
 drainer, 1800mm

### Short Form Specification

**Item No.** \_\_\_\_\_

Entirely made from stainless steel. The 50mm high worktop in 304 AISI stainless steel, 1mm in thickness, has an overflow rim and welded corners. Integral rear upstand, h=100mm, with 8mm radius. All-round apron (except where the dishwasher is placed). Lower shelf placed under the bowls. Square section legs 40x40mm on 1" height-adjustable feet (+/-20mm)

N. 2 bowls mm500x500x300h with overflow pipe and 2" drain hole; drainer (on the right hand side) with void under space to lodge an undercounter dishwasher.

### Main Features

- Sturdiness, stability and reliability of table accurately tested.

### Construction

- Sink tops easily slotted onto the legs and taps are easily installed from the rear.
- Square section legs and 40 mm height-adjustable feet in 304 AISI stainless steel.
- 100 mm upstand with 8 mm radiused corner and 13 mm deep, designed to be used against a wall.
- 50 mm worktop in 304 AISI stainless steel, 10/10 in thickness with overflow rim along the top.
- 40 mm-thick lower shelf slots easily into place at a height of 200 mm from the floor. solid shelves supplied as standard, perforated shelves supplied on request.
- Bottom part of drain left free to house an undercounter dishwasher.
- Wide range of taps are available to suit every need.
- Drainage area suitable for drying operations
- 100 mm upstand with 10 mm radiused corner and 13 mm deep, designed to be used against a wall.

### Optional Accessories

- Lower shelf for 1200mm tables and sinks and for 1800 mm undercounter dishwasher sinks PNC 855145
- 3-sided underframe for 1200mm tables PNC 855152
- Wheel kit for cupboards, 4 wheels (2 with brakes), D=100 mm PNC 855299
- Maxi reel retractable hose spray unit, 10m PNC 855320
- Maxi reel retractable hose spray unit, 15m PNC 855321
- Elbow operated mixer tap with spout 3/4", single hole PNC 855322
- Elbow operated mixer tap with short spout 3/4", single hole PNC 855323
- Maxi reel retractable hose spray unit, 6m PNC 855327
- Foot operated mixer tap (hot and cold) with spout 3/4" PNC 855328
- False bottom for right and left hand 500x500 mm bowl PNC 895200
- Single plastic drain syphon 2" for Sinks PNC 895313

**APPROVAL:** \_\_\_\_\_

Front

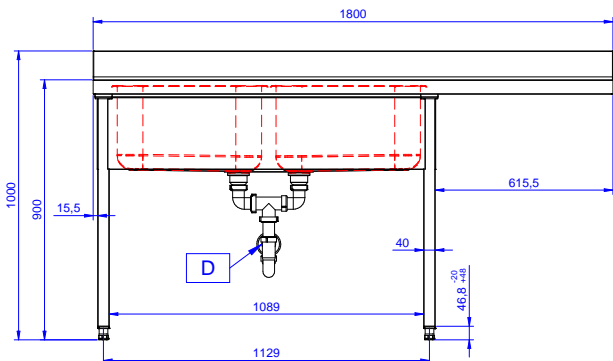

Side

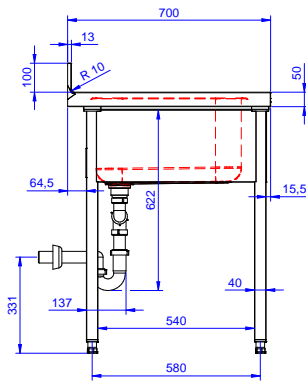

D = Drain

Top

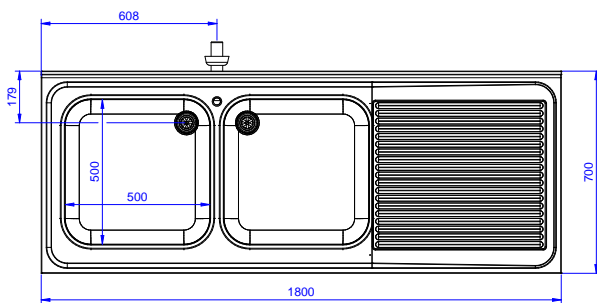

### Key Information:

External dimensions, Width:	1800 mm
133197 (NDBD1817R)	1800 mm
External dimensions, Depth:	700 mm
External dimensions, Height:	1000 mm
Upstand Dimensions, Height:	100 mm
Upstand Dimensions, Depth:	13 mm
Upstand Dimensions, Radius:	R=16
Bowls number	2
Bowl dimensions	500x500xH250
Worktop thickness:	50 mm
Net weight:	62 kg